

Polemic About Junker Test Standard

容克試驗適用性的爭論

Copyright owned by Fastener World / Article by Jozef Dominik

C. O. Bauer: "There is no universal method for locking bolted joints that would be equally effective against all types of stress"

From the above mentioned facts arises the legitimacy of the quotation from the initial part of this article. Every type of bolt connection loading requires a specific securing method. Therefore, there are various laboratorial test methods (**Fig. 1**) and that's why:

There is no universal method of testing bolted joints that would be equally relevant against all types of stress.

Fig. 1. A - cyclical radial loading (as in **Fig. 7**);
B - cyclical axial loading; C - shaking

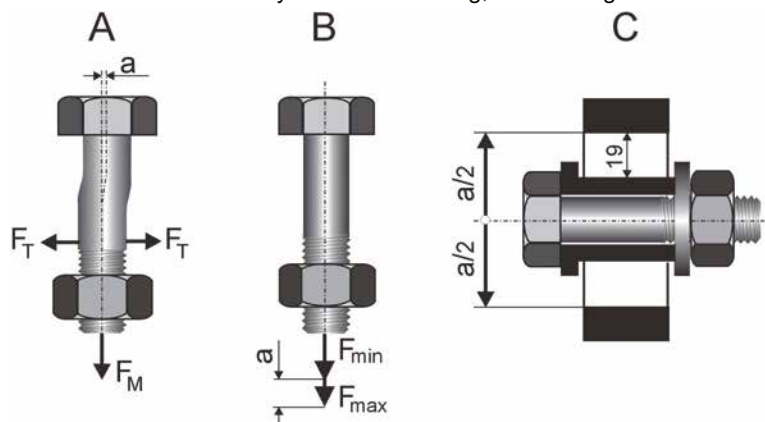

Fig. 2. Junker test - method A



Fig. 3. Axial pulsator – method B



The principle A according to "DIN 65151:2002-08 - Dynamic testing of the locking characteristics of fasteners under transverse loading conditions (vibration test)", known as Junker test is based upon cyclical radial loading shifting at specific frequencies and amplitudes. Type B (**Fig. 3**) is an axial pulsator and type C is clearly a vertically or horizontally oriented vibrational method in accordance with NAS 3350/3354, USA. Illustrative results from method A are shown in **Fig. 4a** schematically and in **Fig. 4b** for real.

As mentioned, every kind of loading requires a specific way of securing and it is also proved in **Fig. 5**, where the evaluation of efficiency of the most commonly used securing elements is introduced.

Fig. 5 shows several typical securing elements to prevent loosening of screw connections during operation which are also used in practice. But as the C. O. Bauer quote at the top of this article, there is no universal way of securing them either. This is clearly illustrated in **Fig. 6** for example.

Fig. 6 demonstrates the striking differences in the resistance of the same wedge washers to individual types of test methods. While it shows an excellent insurance effect according to the Junker test (radial stress - **Fig. 7**), it does not comply with the EDYZ or especially with NASA test. This confirmed that the Junker test cannot be considered as a universal method for testing bolted joints. Logically, it cannot be suitable for the design case in **Fig. 8** for example.



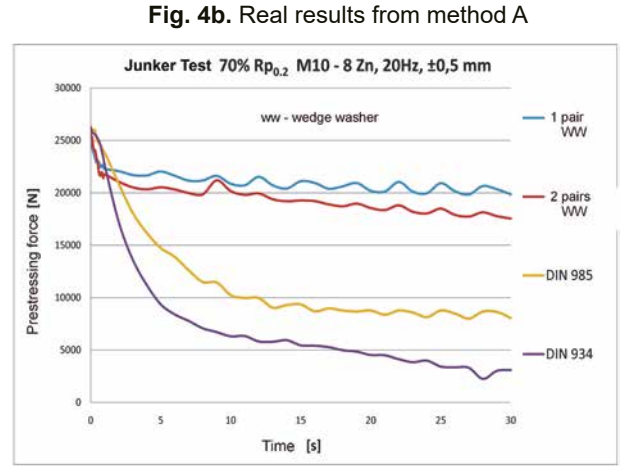
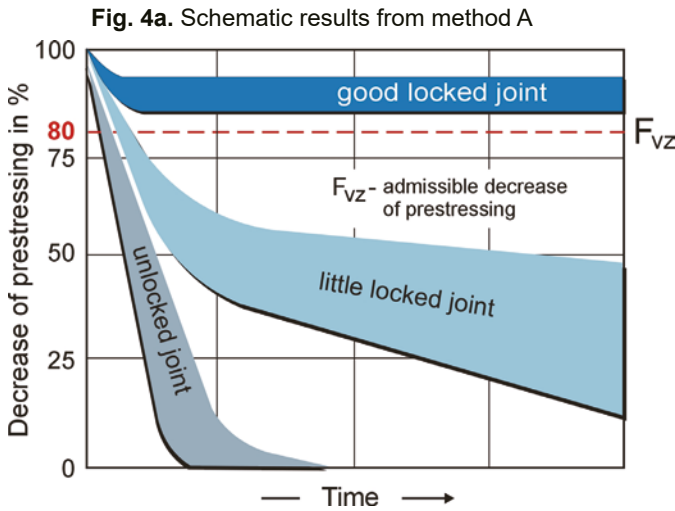

Fig. 5. Several typical securing elements to prevent loosening

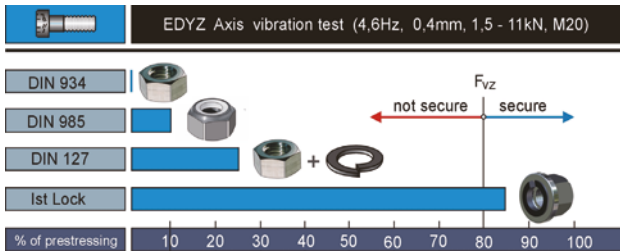
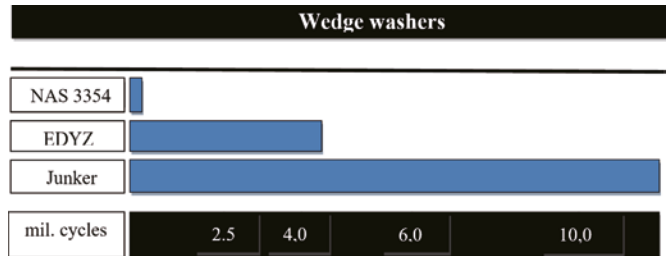

Fig. 6. There is no universal way of securing



For the final decision it is important to take into account all parameters for characteristics of the individual securing elements and to define their degree of importance to choose the optimal solution. **It is important to appoint the correct evaluation criteria. The only correct criterion for choosing a testing method is the matching of the type of stress.** After all, it cannot be correct to use the test method based on cyclic radial loading for structural nodes stressed in the axial direction.

Fig. 7

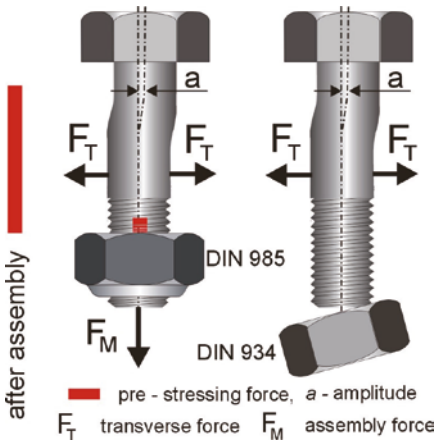
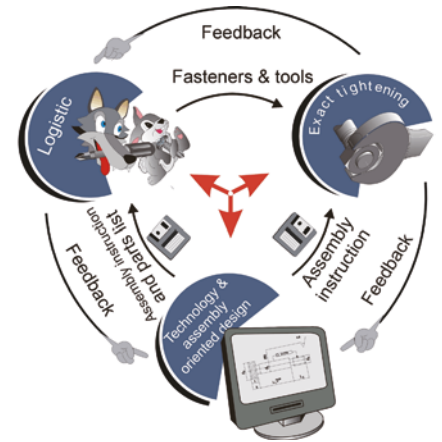

Fig. 8



Fig. 9. Fasteners synergism



Recapitulation

The generally accepted Junker test has been unfortunately uncritically accepted as a universal method of testing bolted joints. Over time, it was even included in the DIN standard. However, as shown, it only applies to specific radial stress cases. **In practice there are many other types of stress where the use of Junker test is not appropriate. As shown, there are other testing methods for such cases.** It is the designer's job to recognize this and make the right decisions. It is important not to succumb to mindlessly bombastic advertising. Designers should be extremely wary of such commercial advertisements. It is their duty. Logistics must respect the designer's decisions and not the other way around. This is the fundamental principle of the relationship between construction and logistics. The relationship between construction, logistics and assembly, named as fasteners synergisms is clearly shown in Fig. 9.

The present article does not have the ambition to recommend the best solutions, but to give to constructors a guideline of how to achieve it. That's their main mission. □